

Logosol AC/DC Servo Amplifier LS-57P

Doc #713057001 / Rev. 1.5, 06/05/2002

Features

- ❑ **Motors supported:**
 - Panasonic A or S series
 - Brushless 60°/120° commutated
 - Brush-commutated
- ❑ **18 to 180VDC single power supply**
- ❑ **Up to 20A peak / 12A continuous current**
- ❑ **Selectable modes of operation:**
 - Current (Torque)
 - Encoder Velocity
 - Analog position
 - Tach Velocity
 - Hall Velocity
- ❑ **Individually adjustable continuous and peak current limits**
- ❑ **Comprehensive short-circuit protection:**
 - Output to output
 - Output to ground
 - Output to power
- ❑ **Over/under voltage shutdown**
- ❑ **Internal fast blowing fuse for maximum safety**
- ❑ **No integrator windup during power-up or if the amplifier is disabled**
- ❑ **Four quadrant regenerative operation**
- ❑ **Small footprint, low cost, easy to use**

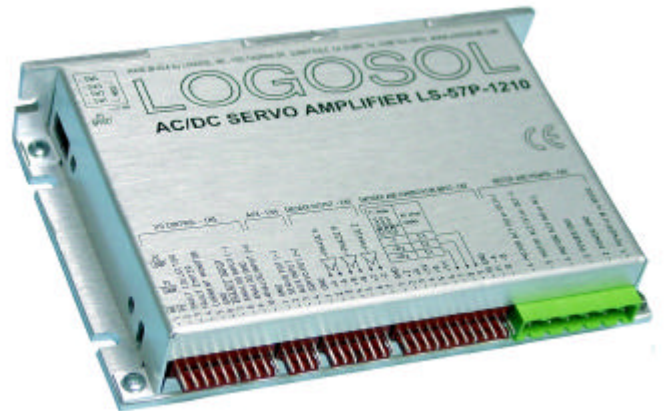

Description:

LS-57P servo amplifier is designed for applications using Panasonic A or S series motors, brushless, or brush-commutated DC motors up to 1 HP. It provides a full set of features for motor control including amplifier enable, direction enable inputs for connection to limit switches, and all necessary protections for motor, and amplifier. LS-57P can be used in conjunction with digital servo controllers or as a stand-alone drive.

Input gain, loop gain and offset can be adjusted. The offset potentiometer can also be used as on-board full range reference signal.

A configurable component carrier and mode switches are used to select the operation mode and to customize the amplifier for specific motor parameters. Individually adjustable peak and continuous current limits allow high acceleration without sacrificing protection against continuous overloads. Peak current time can be adjusted from 50 ms to 3 sec.

Logosol AC/DC Servo Amplifier LS-57P

Doc #713057001 / Rev. 1.5, 06/05/2002

TECHNICAL SPECIFICATIONS rated at 25°C ambient, POWER (+)=60VDC, Load=250μH motor

DC POWER SUPPLY VOLTAGE LS-57P-620 LS-57P-1210 LS-57P-2010	18 to 180VDC (200VDC Abs. Max) 18 to 90VDC (100VDC Abs. Max) 18 to 90VDC (100VDC Abs. Max)
OUTPUT CURRENT LS-57P-620 Peak / continuous LS-57P-1210 Peak / continuous LS-57P-2010 Peak / continuous	6A / 4A 12A / 8A 20A / 12A
OPERATING MODES	Current (torque) - as delivered Encoder Velocity Analog Position Tach Velocity Hall Velocity
COOLING Convection cooling Forced air cooling or heatsink maintaining 60°C max	Output continuous current less than: ± 2A - LS-55x-620 ± 4A - LS-55x-1210 ± 6A - LS-55x-2010 Current higher than listed above
OUTPUT VOLTAGE	$V_{out} = 0.96(HV) - 0.21(I_{out})$
MINIMUM LOAD INDUCTANCE	200μH
SMALL SIGNAL BANDWIDTH Note: actual bandwidth will depend on power supply voltage, load inductance, and configurable components	2.5KHz with 250μH load
PWM SWITCHING FREQUENCY	25KHz
ANALOG INPUT CHARACTERISTICS	Differential, ±10V (±20V max), 50K to GND
GAINS - Current mode LS-57P-620 LS-57P-1210 LS-57P-2010	0.5 A/V as delivered. Adjustable 0 to 5 A/V 1 A/V as delivered. Adjustable 0 to 10 A/V 1.6 A/V as delivered. Adjustable 0 to 16 A/V
POTENTIOMETERS INPUT GAIN LOOP GAIN OFFSET	Attenuates ANALOG INPUT from x 1 to zero Increases A/V gain in current mode Controls bandwidth in velocity mode ORR = 10M – adjusts the imbalance in the input signal or in the servo amplifier ORR = 220K – can be used as on board reference signal driving servo amplifier output up to ±100%
COMMUTATION	60/120° hall and Panasonic modes
ENCODER AND COMMUTATOR INPUTS	HI: ≥ 1.5V, LO: ≤ 0.9V (-0.5VDC to + 5.5VDC Abs. Max) Hysteresis TYP. = 0.6V, Pull up to +5V = 3K3
AUX INPUT	±3V to ±50VDC (±60V Abs.Max)
LOGIC INPUTS ENABLE INPUT PE NE	HI: ≥ 2.0V, LO: ≤ 0.8V (-0.5VDC to + 48VDC Abs. Max) LO enables amplifier, HI (OPEN) inhibits LO enables positive direction rotation, HI (OPEN) inhibits LO enables negative direction rotation, HI (OPEN) inhibits
POWER UP DELAY	<1.5 sec
FAULT OUTPUT Optocoupler Umax=35V Imax=20mA	ON - when operates normally OFF - when amplifier is disabled, motor output is shorted, temperature sensor is activated, or power supply is out of range
INDICATOR (LED)	GREEN when operating normally RED when amplifier is disabled, output is shorted, temperature sensor is activated, or power supply is out of range
CURRENT MONITOR 10K, 10nF RC filter LS-57P-620 LS-57P-1210 LS-57P-2010	± 3.6V at ±6A (0.6V/A) ± 3.6V at ±12A (0.3V/A) ± 3.6V at ±20A (0.18V/A)
PROTECTION Output short (output to output, output to ground, output to POWER (+)) Power supply voltage too low (undervoltage) Power supply voltage too high (overvoltage) Overtemperature	Shutdown when output is shorted with self resume Shutdown at POWER (+) < 18VDC with self resume Shutdown (with self resume) at: POWER (+) > 91VDC for LS-57P-1210, LS-57P-2010 POWER (+) > 180VDC for LS-57P-620 Shutdown at 75 °C internal temperature with self resume
FIRE SAFETY – internal fuse	10A Quick blow
POWER DISSIPATION Minimum power consumption at 0A output, 18VDC power supply Power dissipation at 5A output, 60VDC power supply Power dissipation at 10A output, 60VDC power supply	2W 16W 32W
THERMAL REQUIREMENTS Storage temperature range Operating temperature range	-30 to +85 °C 0 to 45 °C
MECHANICAL Size Weight	5.5 x 3.5 x 1 in. (140 x 89 x 25.4 mm) 0.65 lb. (0.3 kg)

Logosol AC/DC Servo Amplifier LS-57P

Doc #713057001 / Rev. 1.5, 06/05/2002

MATING CONNECTORS	RECOMMENDED CONNECTOR TYPE
MOTOR AND POWER	Magnum EM2565-06-VL or Phoenix: MSTB 2.5/6-ST-5.08
ENCODER AND COMUTATOR INPUT	Molex: 22-01-3127 housing with 08-50-0114 pins (12pcs)
ENCODER OUTPUT	Molex: 22-01-3077 housing with 08-50-0114 pins (7pcs)
AUX	Molex: 22-01-3047 housing with 08-50-0114 pins (4pcs)
I/O CONTROL	Molex: 22-01-3107 housing with 08-50-0114 pins (10pcs)

OUTLINE DIMENSIONS in inches

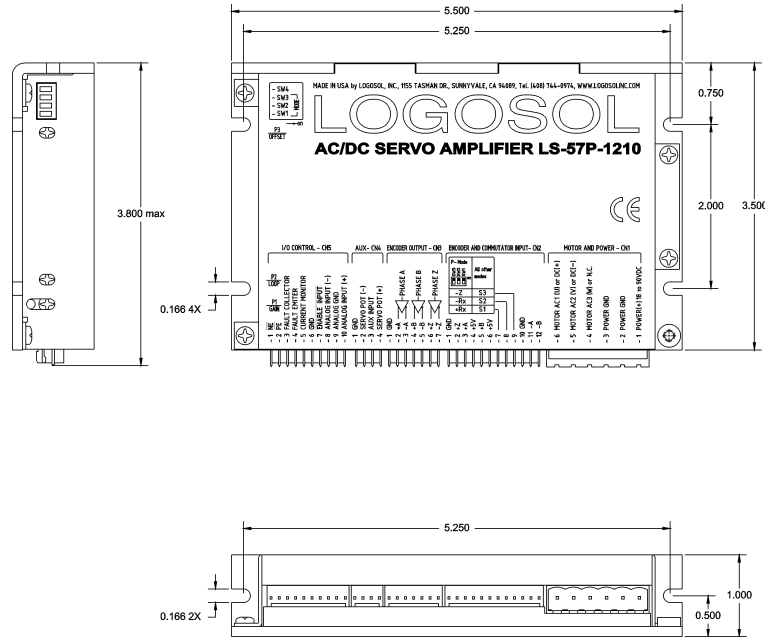

AMPLIFIER LAYOUT

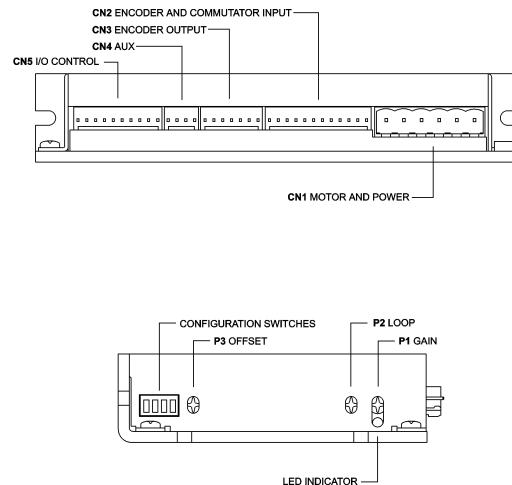

ORDERING GUIDE

PART NUMBER	MODEL	DESCRIPTION
923057002	LS-57P-620	AC/DC Servo Amplifier 6A/200V
923057001	LS-57P-1210	AC/DC Servo Amplifier 12A/100V
923057003	LS-57P-2010	AC/DC Servo Amplifier 20A/100V
230601026	LS-56-CN	Mating connector kit
230601017	PAN-AS-CN	Mating connector kit for Panasonic A and S series motors
230601027	PAN-ASB-CN	Mating connector kit for Panasonic A and S series motors with brake

Logosol AC/DC Servo Amplifier LS-57P

Doc #713057001 / Rev. 1.5, 06/05/2002

CONNECTORS AND PINOUTS

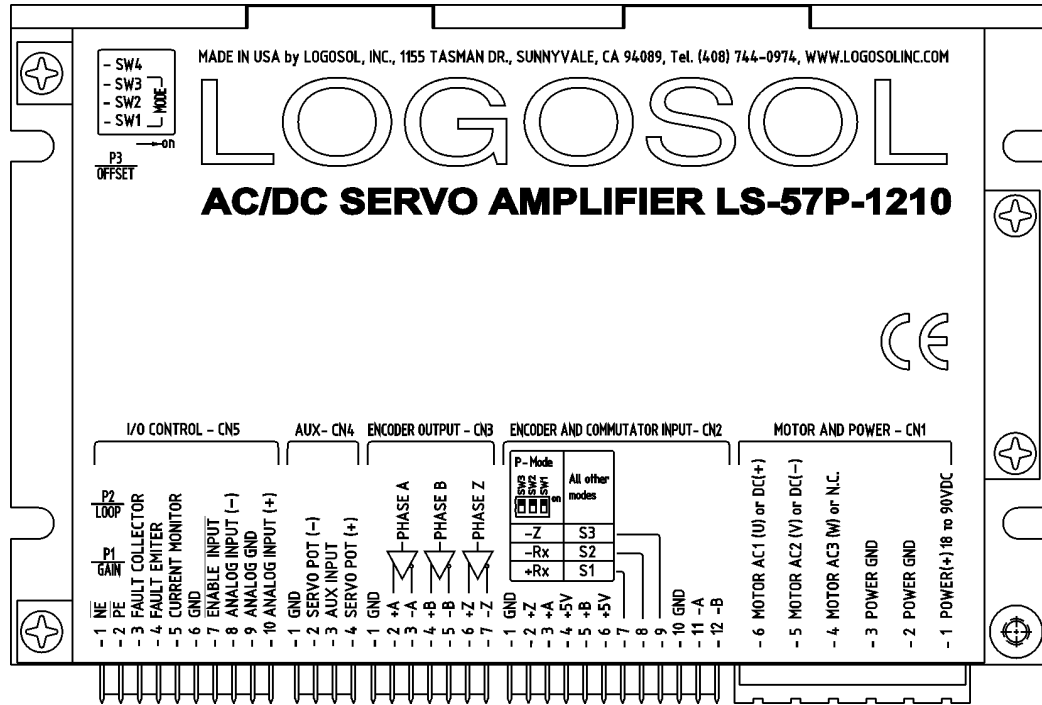

CN1 – MOTOR AND POWER

PIN	SIGNAL	DESCRIPTION
1	POWER +18 to +90VDC	DC Power Supply Input LS-57P-1210, LS-57P-2010 - 18 to 90VDC LS-57P-620 - 18 to 180VDC
2 and 3	POWER GND*	Power Supply Return and Amplifier GROUND
4	MOTOR AC3 (W) or NC	Amplifier Output to Motor phase 3 for brushless and Panasonic A or S motors Not connected for brush motors
5	MOTOR AC2 (V) or DC(-)	Amplifier Output to Motor phase 2 for brushless and Panasonic A or S motors Amplifier Output to Motor (-) terminal for brush motors
6	MOTOR AC1 (U) or DC(+)	Amplifier Output to Motor phase 1 for brushless and Panasonic A or S motors Amplifier Output to Motor (+) terminal for brush motors

CN2 – ENCODER AND COMMUTATOR INPUT

PIN	SIGNAL	DESCRIPTION
1	GND*	Encoder ground
2	+Z	Encoder Index positive terminal
3	+A	Encoder phase A positive terminal
4	+5V	Encoder power supply
5	+B	Encoder phase B positive terminal
6	+5V	Commutator power supply
7	+RX S1	Hall data for Panasonic A or S motors Hall sensor input 1 for brushless motors, NC for brush motors
8	-RX S2	Hall data for Panasonic A or S motors Hall sensor input 2 for brushless motors, NC for brush motors
9	-Z S3	Encoder Index negative terminal for Panasonic A or S motors Hall sensor input 3 for brushless motors, NC for brush motors
10	GND*	Commutator ground
11	-A	Encoder phase A negative terminal
12	-B	Encoder phase B negative terminal

*Note: POWER GND, GND and ANALOG GND are electrically connected. Amplifier case is isolated from the amplifier circuitry and can be grounded externally.

Logosol AC/DC Servo Amplifier LS-57P

Doc #713057001 / Rev. 1.5, 06/05/2002

CN3 – ENCODER OUTPUT

PIN	SIGNAL	DESCRIPTION
1	GND*	Signal ground
2	+A	Phase A output positive terminal
3	-A	Phase A output negative terminal
4	+B	Phase B output positive terminal
5	-B	Phase B output negative terminal
6	+Z	Index output positive terminal
7	-Z	Index output negative terminal

CN4 – AUX

PIN	SIGNAL	DESCRIPTION
1	GND*	Signal ground
2	SERVO POT (-)	-5V Reference voltage output with 1K5 resistor in series
3	AUX INPUT	Tachometer input Potentiometer input in analog position mode
4	SERVO POT (+)	+5V Reference voltage output with 1K5 resistor in series

CN5 – I/O CONTROL

PIN	SIGNAL	DESCRIPTION
1	$\overline{\text{NE}}$	LO (GND) if the direction is enabled HI (OPEN) if the direction is disabled
2	$\overline{\text{PE}}$	LO (GND) if the direction is enabled HI (OPEN) if the direction is disabled
3	FAULT COLLECTOR	Optocoupler Fault = OFF (open)
4	FAULT EMITER	
5	CURRENT MONITOR	Current monitor output LS-57P-620 - ± 0.6 V/A LS-57P-1210 - ± 0.3 V/A LS-57P-2010 - ± 0.18 V/A
6	GND*	Signal ground
7	$\overline{\text{ENABLE INPUT}}$	Amplifier enable input LO (GND) enables the amplifier HI (OPEN) disables the amplifier
8	ANALOG INPUT (-)	Negative analog input ± 10 V
9	ANALOG GND*	Analog ground
10	ANALOG INPUT (+)	Positive analog input ± 10 V

*Note: POWER GND, GND and ANALOG GND are electrically connected. Amplifier case is isolated from the amplifier circuitry and can be grounded externally.

DIP SW – MODE SELECT SWITCHES

SW1	SW2	SW3	SW4	Encoder	MODE SELECT TABLE
ON	ON	ON	ON	2500	Panasonic - any mode
OFF	ON	ON	ON	X	Brush or Brushless motors - any mode other than Hall and Encoder Velocity
SYNC*	OFF	ON	ON	X	Brushless motors - Hall Velocity mode
ON	ON	OFF	ON	2500	Brush or Brushless motors - Encoder Velocity mode
ON	ON	OFF	ON	2000/2048	
ON	ON	OFF	ON	1500/1536	
OFF	ON	OFF	ON	1000/1024	
OFF	ON	OFF	ON	750/768	
ON	OFF	OFF	ON	500/512	
OFF	OFF	OFF	ON	250/256	
OFF	OFF	OFF	ON	100/128	

*NOTE: SYNC should be ON or OFF depend on motor winding / hall sensor phasing.

POTENTIOMETER FUNCTIONS

POT.	FUNCTION	DESCRIPTION
P1	INPUT GAIN	Adjusts the ratio between the analog input signal and servo amplifier output
P2	LOOP GAIN	Adjusts voltage to current transfer ratio in current mode Adjusts loop gain and bandwidth in velocity, open loop and analog position modes
P3	OFFSET	ORR = 10M – compensates the input signal imbalance and servo amplifier offset (low range) ORR = 220K – on board reference signal source driving amplifier output up to $\pm 100\%$

Logosol AC/DC Servo Amplifier LS-57P

Doc #713057001 / Rev. 1.5, 06/05/2002

FUNCTIONAL DIAGRAM

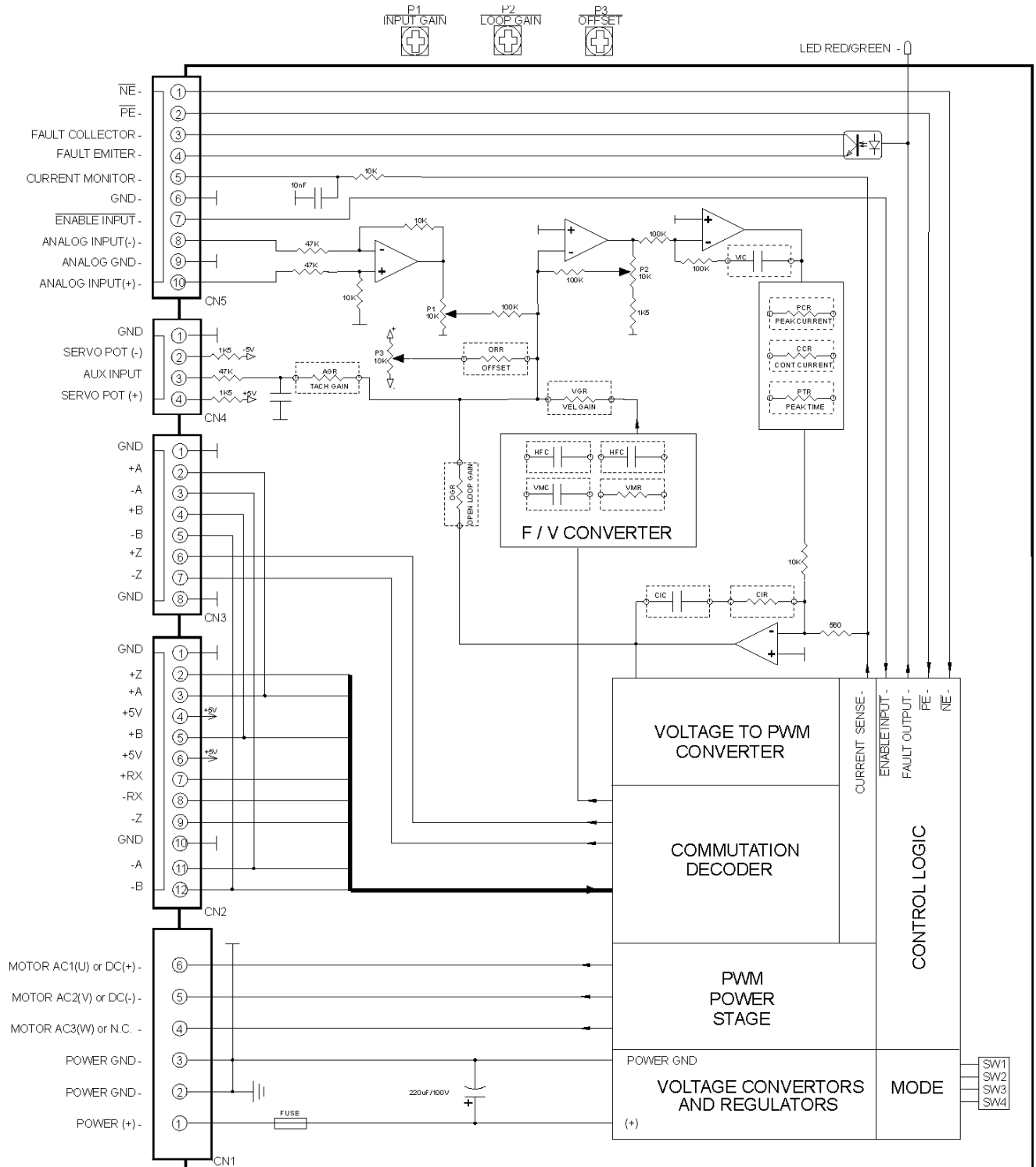

Logosol AC/DC Servo Amplifier LS-57P

Doc #713057001 / Rev. 1.5, 06/05/2002

MODE SELECT TABLES

Set the mode switches according to the table:

MOTOR TYPE – MODE	Encoder	SW1	SW2	SW3	SW4
Panasonic - any mode	2500	ON	ON	ON	ON
Brush or Brushless motors - any mode other than Hall and Encoder Velocity	X	OFF	ON	ON	ON
Brushless motors - Hall Velocity mode	X	SYNC*	OFF	ON	ON
Brush or Brushless motors - Encoder Velocity mode	2500	ON	ON	OFF	ON
	2000/2048	ON	ON	OFF	ON
	1500/1536	ON	ON	OFF	ON
	1000/1024	OFF	ON	OFF	ON
	750/768	OFF	ON	OFF	ON
	500/512	ON	OFF	OFF	ON
	250/256	OFF	OFF	OFF	ON
100/128	OFF	OFF	OFF	ON	

*NOTE: SYNC should be ON or OFF depend on motor winding / hall sensor phasing.

Install the appropriate components on **Configurable Component Carrier** according to the table:

MODE	PCR	CCR	CIR	CIC	VIC	PTR	OGR	ORR	AGR	VGR	VMR	VMC	HFC
Torque	R	R	R	C	SHORT	R	OPEN	R	OPEN	OPEN	100K	OPEN	OPEN
Encoder velocity	R	R	R	C	C	R	OPEN	R	OPEN	R	100K	1nF	OPEN
Hall velocity	R	R	R	C	C	R	OPEN	R	OPEN	R	R	10nF	2x 10nF
Open loop	R	R	R	C	C	R	R	R	OPEN	OPEN	100K	OPEN	OPEN
Tach velocity	R	R	R	C	C	R	OPEN	R	R	OPEN	100K	OPEN	OPEN
Analog position	R	R	R	C	C	R	Typically 1M	R	Typically 47K	OPEN	100K	OPEN	OPEN

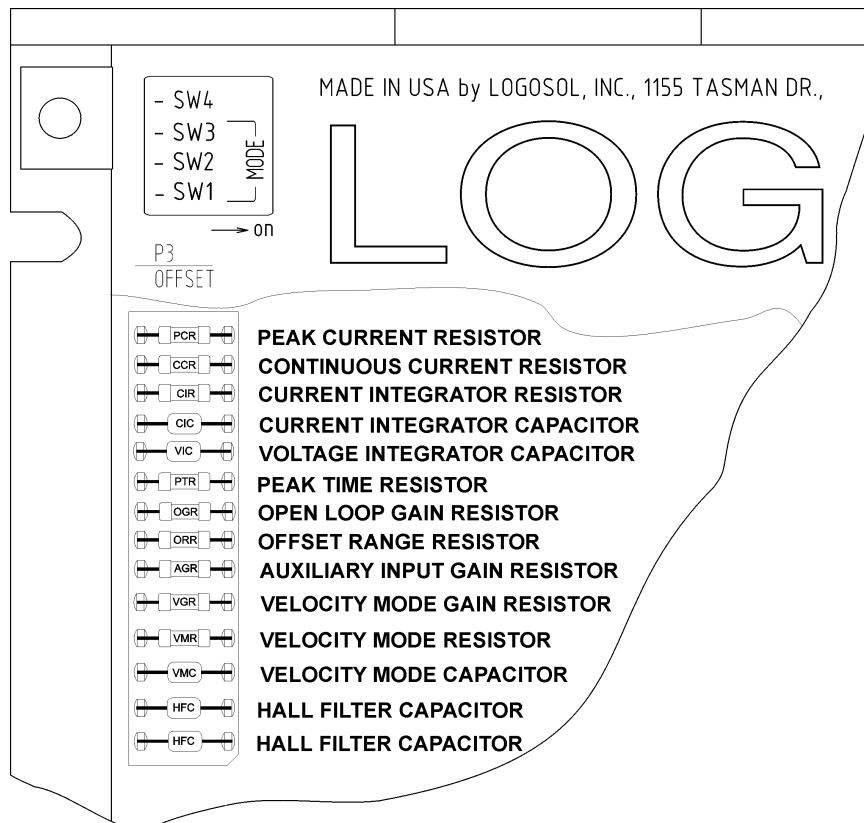

Logosol AC/DC Servo Amplifier LS-57P

Doc #713057001 / Rev. 1.5, 06/05/2002

CONFIGURABLE COMPONENTS SETTING

PCR is the adjusting resistor for peak current limit (*factory standard setting - PCR=SHORT*).

CCR is the adjusting resistor for continuous current limit (*factory standard setting - CCR=SHORT*).

The table below shows component values for the most used continuous and peak current combinations.

I peak (A) LS-57P- 620 / 1210 / 2010	I cont (A) LS-57P- 620 / 1210 / 2010	PCR	CCR	I peak (A) LS-57P- 620 / 1210 / 2010	I cont (A) LS-57P- 620 / 1210 / 2010	PCR	CCR
6 / 12 / 20	4 / 8 / 13	SHORT	SHORT	3 / 6 / 10	1.7 / 3 / 5	27K	36K
6 / 12 / 20	3 / 6 / 10	SHORT	10K	2.5 / 5 / 8.3	1.2 / 2.5 / 4.2	36K	47K
5 / 10 / 17	3 / 6 / 10	5K6	5K6	2 / 4 / 7	1 / 2 / 3.3	56K	75K
5 / 10 / 17	2.5 / 5 / 8	5K6	16K	1.7 / 3 / 5	0.7 / 1.5 / 2.5	82K	110K
4 / 8 / 13	2 / 4 / 7	15K	24K	1 / 2 / 3.3	0.5 / 1 / 1.7	130K	150K
3.5 / 7 / 12	1.8 / 3.5 / 6	20K	30K	0.5 / 1 / 1.7	0.2 / 0.5 / 0.8	220K	330K

CIR is the current integrator resistor (*factory standard setting - CIR=22K*).

CIC is the current integrator capacitor (*factory standard setting - CIC=100nF*).

The values of these components are related to the amplifier bandwidth and have to be configured depending on the motor inductance and power supply voltage.

Optimization procedure

Set the amplifier in current mode by putting jumper wire instead of **VIC**. Set **P1** and **P2** fully CCW. Connect the motor and power supply to the amplifier. Apply a square wave signal $\pm 1V$ at 20 to 50Hz to amplifier **ANALOG INPUT**. Use an oscilloscope to measure the signal at current monitor (**CN5**-pin4). Enable the amplifier **AMP ENABLE**=LOW. Rotate **P1** CW to set $\pm 150mV$ square wave signal at the oscilloscope screen. Using **CIR** selected from the table below, select lowest value of **CIC** that does best result in overshoot or degradation of the pulse response.

The table below shows some approximate values of the current integrator resistor and capacitor depending of motor inductance.

LOAD INDUCTANCE	CIC	CIR
0.2 ÷ 0.6mH	47nF	10K
0.7 ÷ 1.9mH	100nF	10K
2 ÷ 6mH	100nF	22K
7 ÷ 20mH	220nF	22K

Note: Values in the table are for 24VDC power supply voltage. For higher voltages **CIR** should be decreased and **CIC** increased.

VIC is the voltage integrator capacitor (*factory standard setting - VIC=SHORT*).

For current mode this capacitor is replaced by a wire jumper or 0 Ohm resistor. Changing of the wire jumper with a capacitor is necessary for all velocity, open loop and analog position modes.

Proceed with **CIR** and **CIC** optimization before **VIC** optimization.

Optimization procedure for TACH VELOCITY mode

Set the amplifier in velocity mode putting **VIC** = 220nF. Set **P1** fully CCW. Connect motor and tachometer. Power and enable the amplifier. Rotate the motor shaft manually. If the tachometer polarity is wrong, the motor will "Run away". If this happens, reverse tachometer wires **(+)** and **(-)**. With correct tachometer polarity, the motor will resist the manual rotation of its shaft. Apply square wave signal $\pm 1V$ at 5 to 20 Hz to amplifier **ANALOG INPUT**. Move the oscilloscope probe to **AUX INPUT** pin. Rotate **P1** CW to set $\pm 1V$ square wave signal at the oscilloscope screen. Find the best response (lowest rise time with minimum overshoots) by changing **VIC** and adjusting **P2 LOOP GAIN**.

Logosol AC/DC Servo Amplifier LS-57P

Doc #713057001 / Rev. 1.5, 06/05/2002

Optimization procedure for **ENCODER VELOCITY** mode

Set the amplifier in velocity mode putting **VIC** = 220nF. Set **P1** fully CCW. Connect motor and encoder. Power and enable the amplifier. Rotate motors shaft slightly. If the encoder polarity is wrong the motor will "Run away". If this happens, swap encoder wires **+A/+B** and **-A/-B**. With correct encoder polarity, the motor will resist the manual rotation of its shaft. Apply square wave signal $\pm 1V$ at 5 to 20 Hz* to amplifier **ANALOG INPUT**. Move the oscilloscope probe to the control point shown on the picture below:

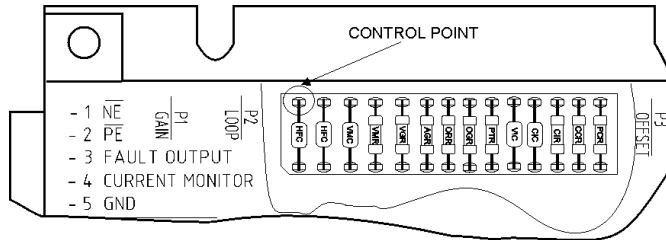

Rotate **P1** CW to set $\pm 250mV$ square wave signal at the oscilloscope screen. Find the best response (lowest rise time with minimum overshoots) by changing **VIC** and adjusting **P2 LOOP GAIN**.

Note: * For max speed 5000 rpm. For max speed 2500 rpm apply $\pm 2V$ at 5 to 20Hz.

PTR is adjusting resistor for the **PEAK TIME** (*factory standard setting - PTR=OPEN*). The table below shows some basic settings.

PEAK TIME	PTR	PEAK TIME	PTR
3 sec	OPEN	0.5 sec	68K
2 sec	510K	0.25 sec	33K
1.5 sec	330K	0.1 sec	15K
1 sec	150K	0.05 sec	SHORT

OGR is open loop gain resistor (*factory standard setting - OGR=OPEN*).

OGR converts the amplifier into a Voltage to PWM converter (**OPEN LOOP** mode).

To setup the **OGR** value use the table:

INPUT VOLATGE	OGR	PWM
$\pm 10V$	68K	100%
$\pm 5V$	130K	100%

ORR is the offset range resistor (*factory standard setting - ORR=10M*).

Its value changes the range of regulation with the **OFFSET** potentiometer. For 100% regulation set the **ORR** = 220K. To reduce the regulation range, increase the resistor. Factory setting **ORR** = 10M gives enough range for input imbalance adjustment. All values greater then 220K can be used

AGR is an adjustment resistor affecting the amplifier in **TACH VELOCITY** and **ANALOG POSITION** modes (*factory standard setting - AGR=OPEN*).

The resistor value changes amplifier auxiliary input sensitivity between ZERO (**AGR=OPEN**) and MAX (**AGR=47K***). Choose the value of **AGR** depending on your application, between 47K and 2M2 (corresponding to $\pm 2V$ and $\pm 50V$ input sensitivity).

*Note: Do not use resistor with lower value than 47K.

Logosol AC/DC Servo Amplifier LS-57P

Doc #713057001 / Rev. 1.5, 06/05/2002

VGR is the **ENCODER VELOCITY** and **HALL VELOCITY** mode gain resistor (*factory standard setting - VGR=OPEN*).

To select the **VGR** value use the following table:

MODE	ENCODER	SW1	SW2	SW3	SW4	VGR / max RPM		
						5Krpm	2.5Krpm	1.5Krpm
Panasonic Velocity	2500	ON	ON	ON	ON	150K	75K	47K
Hall Velocity	X	SYNC*	OFF	ON	ON	150K	75K	47K
Encoder Velocity	2500	ON	ON	OFF	ON	150K	75K	47K
	2000/2048	ON	ON	OFF	ON	120K	60K	36K
	1500/1536	ON	ON	OFF	ON	91K	47K	27K
	1000/1024	OFF	ON	OFF	ON	150K	75K	47K
	750/768	OFF	ON	OFF	ON	110K	56K	33K
	500/512	ON	OFF	OFF	ON	150K	75K	47K
	250/256	OFF	OFF	OFF	ON	150K	75K	47K
	100/128	OFF	OFF	OFF	ON	56K	27K	16K

*NOTE: SYNC should be ON or OFF depend on motor winding / hall sensor phasing.

VMR is **VELOCITY** mode resistor (*factory standard setting - VMR=100K*).

To set the **VMR** use the following table:

MODE	COMMUTATIONS PER REVOLUTION	VMR
Panasonic Velocity	X	100K
Hall Velocity	1	91K
	2	47K
	4	24K
	8	11K
Encoder Velocity	X	100K
All other modes	X	100K

VMC is **VELOCITY** mode capacitor (*factory standard setting - VMC=OPEN*).

To set the **VMC** use the following table:

MODE	VMC
Panasonic Velocity	1nF
Hall Velocity	10nF
Encoder Velocity	1nF
All other modes	OPEN

HFC are two 10nF capacitors used only in **HALL VELOCITY** mode (*factory standard setting - HFC=OPEN*).

MODE	HFC
Panasonic Velocity	OPEN
Hall Velocity	2x10nF
Encoder Velocity	OPEN
All other modes	OPEN

Logosol AC/DC Servo Amplifier LS-57P

Doc #713057001 / Rev. 1.5, 06/05/2002

PHASING A BRUSHLESS MOTOR

CN2 Signal	Motor manufacturer signal names			
S1	R	U	A	S1
S2	S	V	B	S2
S3	T	W	C	S3

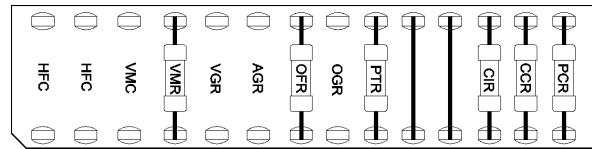

CONFIGURABLE COMPONENT CARRIER

Phasing procedure

Replace configurable components **CIC** and **VIC** with wire jumpers (**SHORT**). Replace **OFR** with resistor 3.0M. Connect the motor commutation sensors to **CN2** using the table with the most popular manufacturers signal names. Connect the commutator power leads (**+5V**, **GND**).

Connect the three motor leads to **AC1**, **AC2**, and **AC3** to **CN1** using the same order as commutation sensor signals. Power and enable the amplifier. Rotate amplifier **OFFSET** potentiometer CW and CCW. If the motor is phased properly it will rotate smoothly in both directions. If the motor runs slower in one direction, needs help to start, or vibrates the phasing is incorrect. There are five more ways to connect the three motor wires. The best way is to try all the six combinations to find the right one which should be quite obvious. If the motor is phased properly, the direction can be reversed interchanging **S1/S3** and **AC1/AC2**.

Logosol AC/DC Servo Amplifier LS-57P

Doc #713057001 / Rev. 1.5, 06/05/2002

TYPICAL CURRENT (TORQUE) MODE APPLICATION FOR BRUSHLESS MOTORS

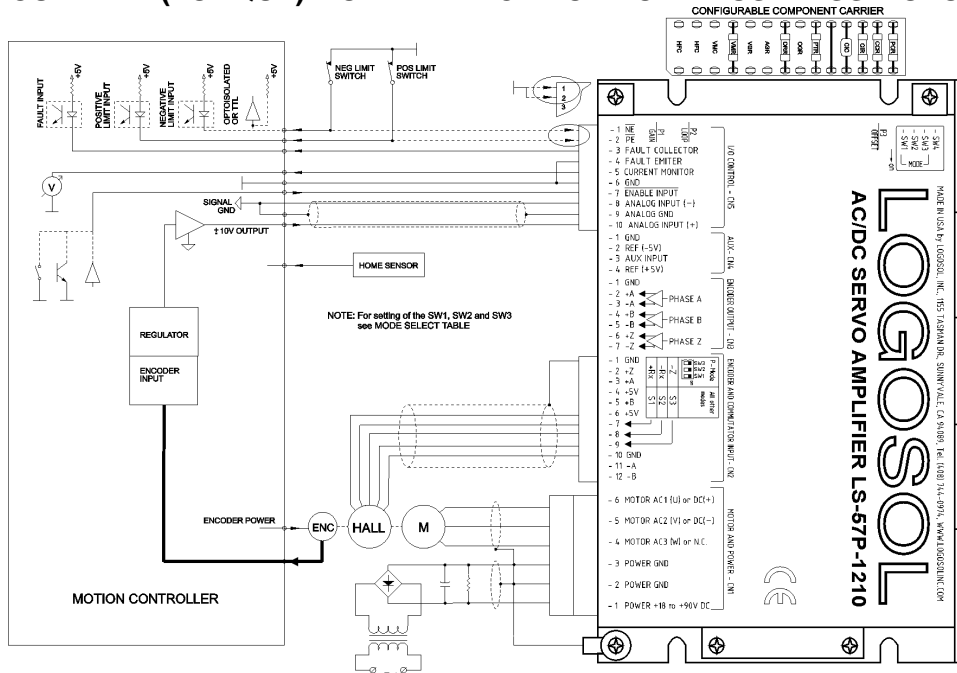

TYPICAL CURRENT (TORQUE) MODE APPLICATION FOR BRUSH MOTORS

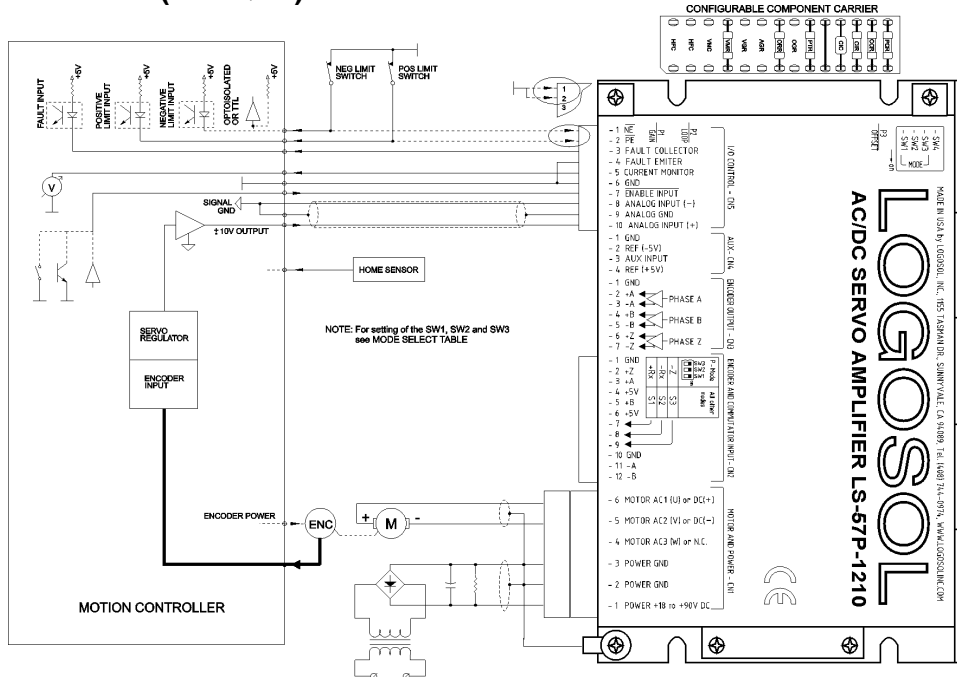

In **CURRENT (TORQUE)** mode the amplifier produces motor current proportional to the voltage applied to the **ANALOG INPUT**. Motor shaft torque is proportional to the motor current. Current mode gives best results (motor stiffness) if the servo amplifier is used with a digital position controller. **P1 INPUT GAIN** and **P2 LOOP GAIN** adjust the ratio between the input signal and amplifier output current. Set **P1 INPUT GAIN** to 50% and **P2 LOOP GAIN** fully CCW. To increase the gain turn **P2** CW. To decrease the gain turn **P1** CCW. In this mode, only **CIC** and **CIR** must be optimized.

CAUTION! Without controller this mode can produce motor "RUN AWAY".

Logosol AC/DC Servo Amplifier LS-57P

Doc #713057001 / Rev. 1.5, 06/05/2002

TYPICAL ENCODER VELOCITY MODE APPLICATION FOR BRUSHLESS MOTORS

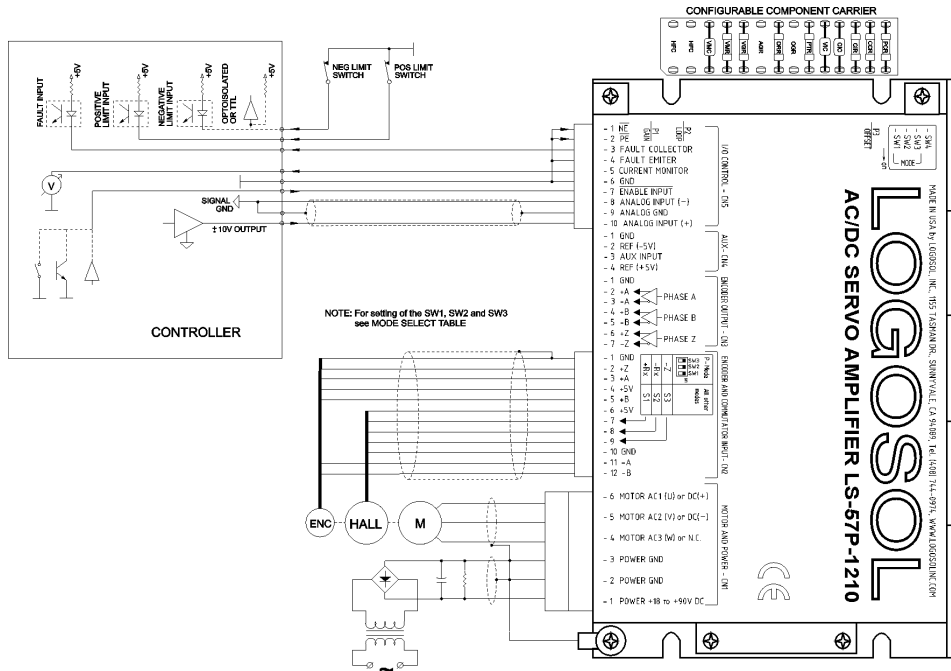

TYPICAL ENCODER VELOCITY MODE APPLICATION FOR BRUSH MOTORS

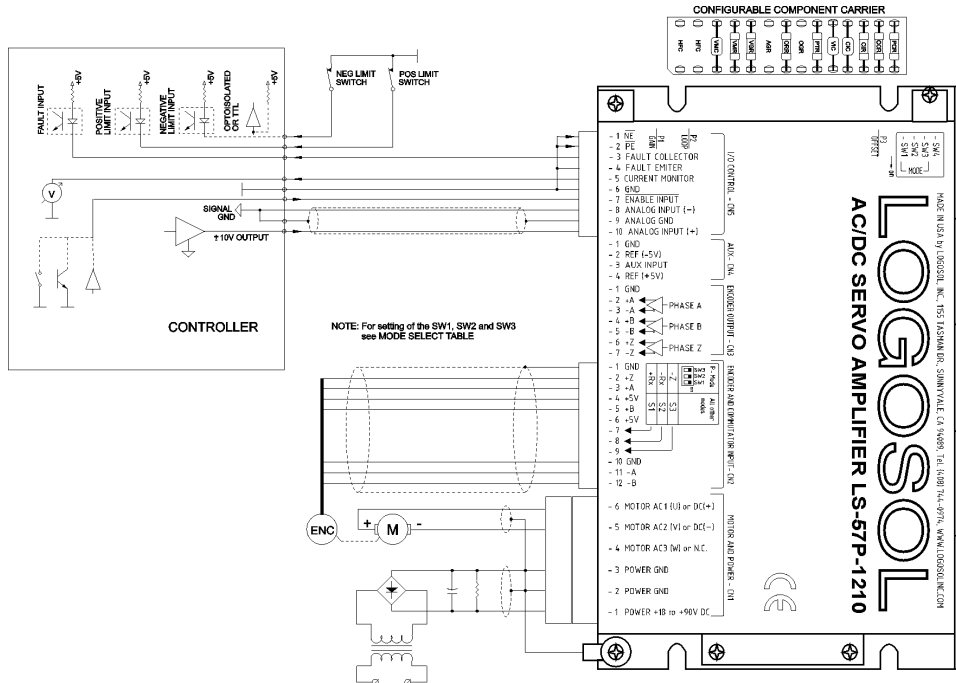

In **ENCODER VELOCITY** mode the motor speed is proportional to the voltage applied to the **ANALOG INPUT**. Encoder signals are used to produce a voltage proportional to the motor shaft speed. Set **P1 INPUT GAIN** fully CCW and **P2 LOOP GAIN** fully CCW. Power and enable the amplifier. Spin the motor shaft manually. If the motor “runs away” swap encoder wires **+A/+B** and **-A/-B**. In this mode, the configurable components **CIC**, **CIR**, and **VIC** must be optimized. **P1 INPUT GAIN** adjusts the ratio between **ANALOG INPUT** voltage and motor speed. **P2 LOOP GAIN** adjusts amplifier loop gain and bandwidth (system stability).

Logosol AC/DC Servo Amplifier LS-57P

Doc #713057001 / Rev. 1.5, 06/05/2002

TYPICAL ANALOG POSITION MODE APPLICATION FOR BRUSHLESS MOTORS

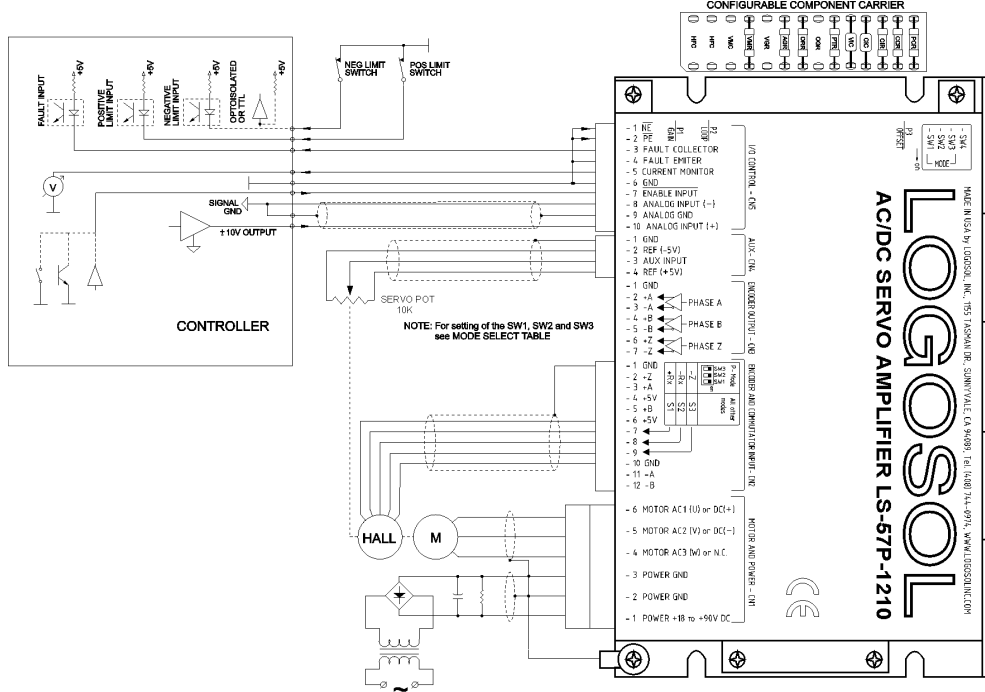

TYPICAL ANALOG POSITION MODE APPLICATION FOR BRUSH MOTORS

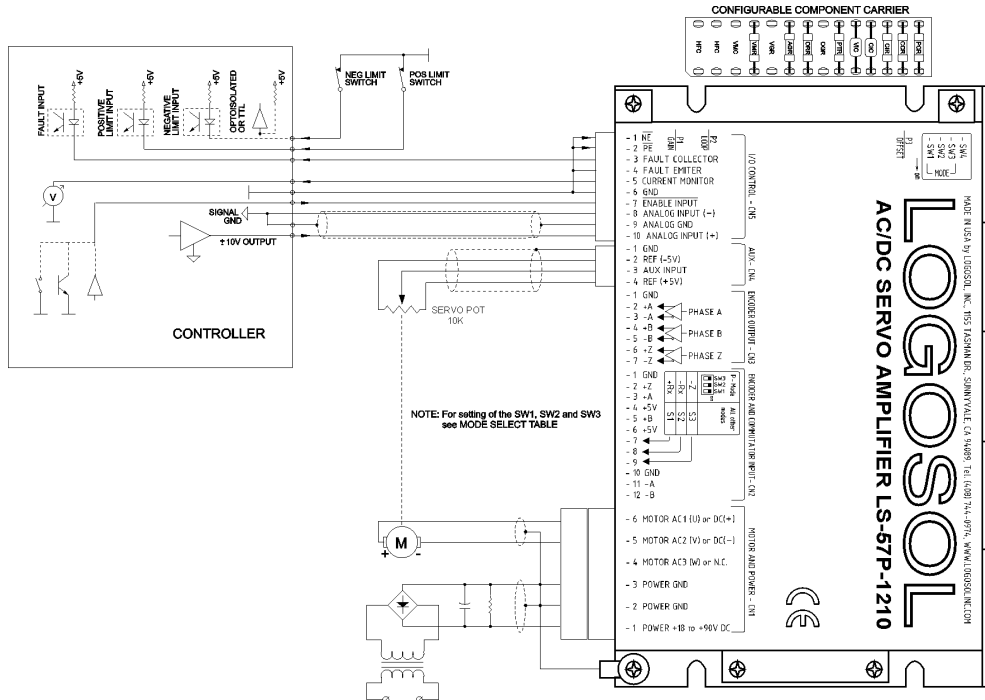

In **ANALOG POSITION** mode, an analog 10K potentiometer is mechanically coupled to the positioned object. The potentiometer supplies voltage proportional to its position. This voltage is used as a feedback signal, keeping the motor (potentiometer) position proportional to the reference input voltage. Select **AGR** between 47K and 2M2 ($\pm 2V$ to $\pm 50V$ input) depending on your application.

Logosol AC/DC Servo Amplifier LS-57P

Doc #713057001 / Rev. 1.5, 06/05/2002

TYPICAL TACH VELOCITY MODE APPLICATION FOR BRUSHLESS MOTORS

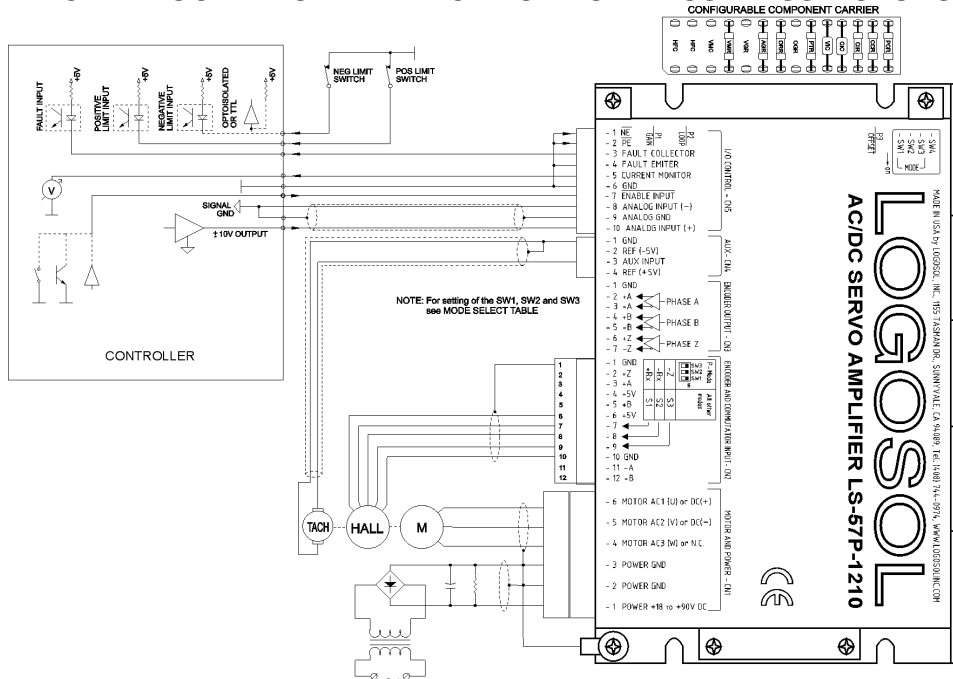

TYPICAL TACH VELOCITY MODE APPLICATION FOR BRUSH MOTORS

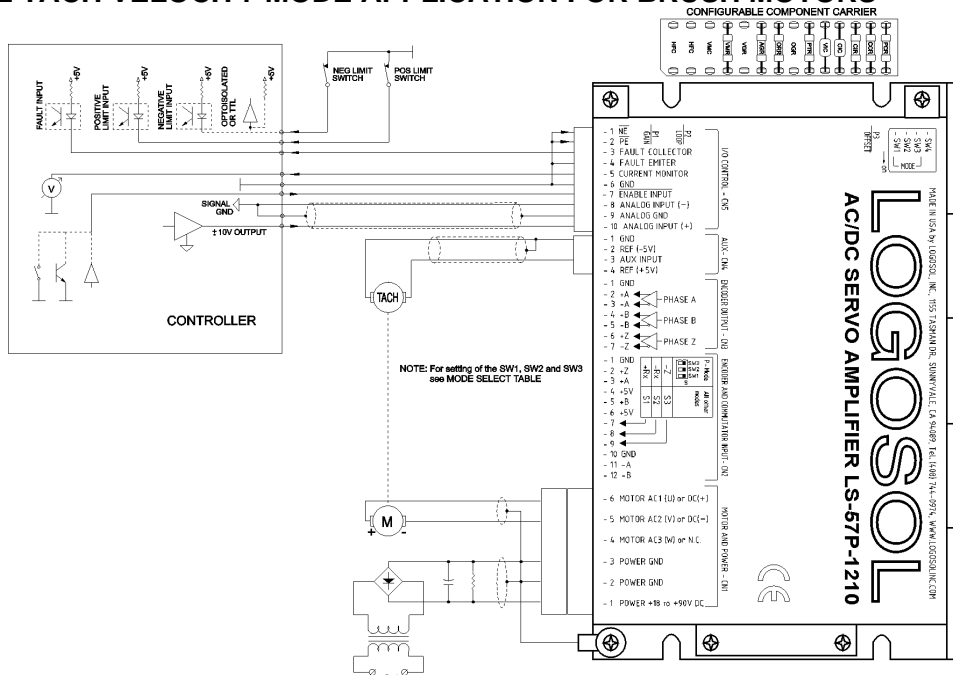

TACH VELOCITY mode is only applicable for motors with tachometers. A tachometer produces a voltage proportional to the motor shaft speed. By using this voltage as a feedback, the amplifier keeps motor shaft speed proportional to the voltage applied to the **ANALOG INPUT**. Set **P1** INPUT GAIN and **P2** LOOP GAIN fully CCW. Power and enable the amplifier. Spin the motor shaft manually. If the motor “runs away”, reverse tachometer or motor polarity. In this mode the configurable components **CIC**, **CIR**, **VIC** and **TGR** must be optimized. **P1** REF GAIN adjusts the ratio between **ANALOG INPUT** voltage and motor rotation speed. **P2** LOOP GAIN adjusts amplifier loop gain and bandwidth (system stability).

Logosol AC/DC Servo Amplifier LS-57P

Doc #713057001 / Rev. 1.5, 06/05/2002

TYPICAL HALL VELOCITY MODE APPLICATION

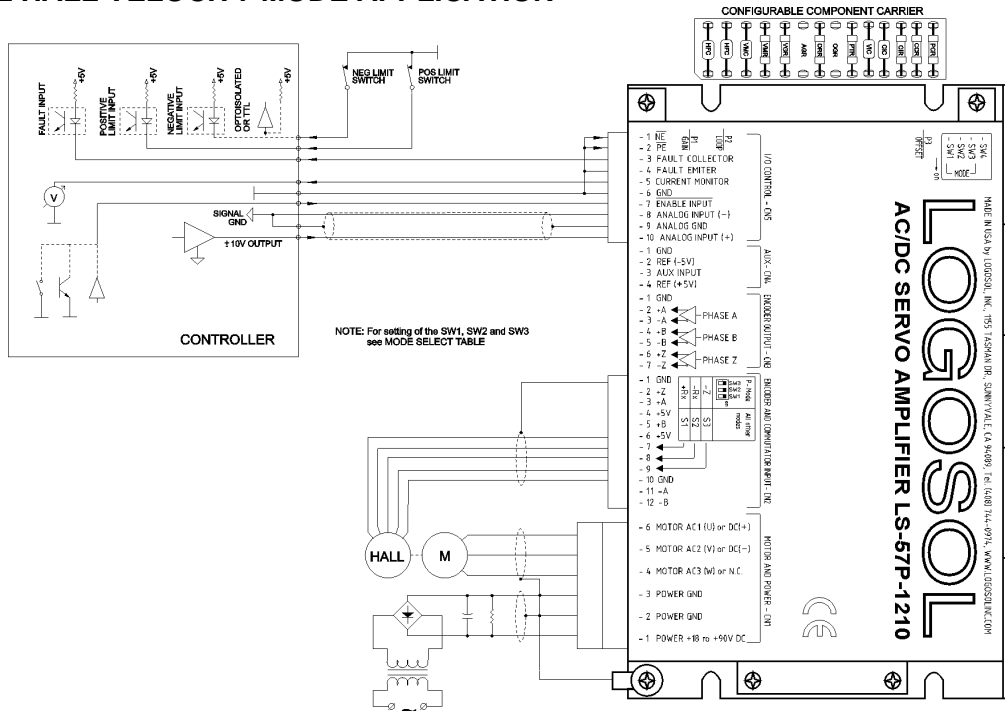

HALL VELOCITY mode is only applicable for brushless motors. Hall signals are used to produce a voltage proportional to the motor shaft speed. Using this feedback, the amplifier keeps motor shaft speed proportional to the reference voltage applied to the **ANALOG INPUT**. Proceed with **Phasing** and **CIC** optimization procedures before switching to this mode. Select **VMR**, **VMC** and **HFC** according the tables given in **Configurable Component Settings**. Set **P1 REF GAIN** fully CCW and **P2 LOOP GAIN** fully CCW. Power and enable the amplifier. Spin the motor shaft manually. Switch **SYNC** if the motor “runs away” (see **Mode Select** table). **P1 REF GAIN** adjusts the ratio between **ANALOG INPUT** voltage and motor rotation speed. **P2 LOOP GAIN** adjusts amplifier loop gain and bandwidth (system stability). This mode will give better results if the motor work speed is more than 300 rpm.

STAND ALONE MODE APPLICATION

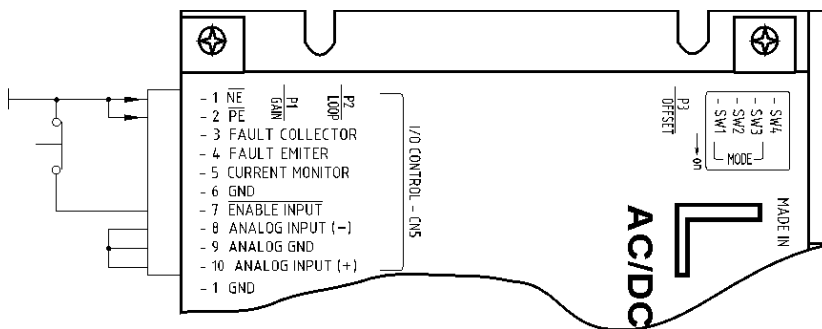

P3 OFFSET is used as an on board reference signal source driving servo amplifier output up to 100% (max range). For full output range set **ORR=220K**. Set **P1 REF GAIN** fully CCW. All remaining settings are the same as described for **CURRENT (TORQUE)**, **ENCODER VELOCITY**, **TACH VELOCITY** or **HALL VELOCITY** modes.

Logosol AC/DC Servo Amplifier LS-57P

Doc #713057001 / Rev. 1.5, 06/05/2002

TYPICAL CURRENT (TORQUE) MODE APPLICATION FOR PANASONIC A OR S SERIES MOTORS

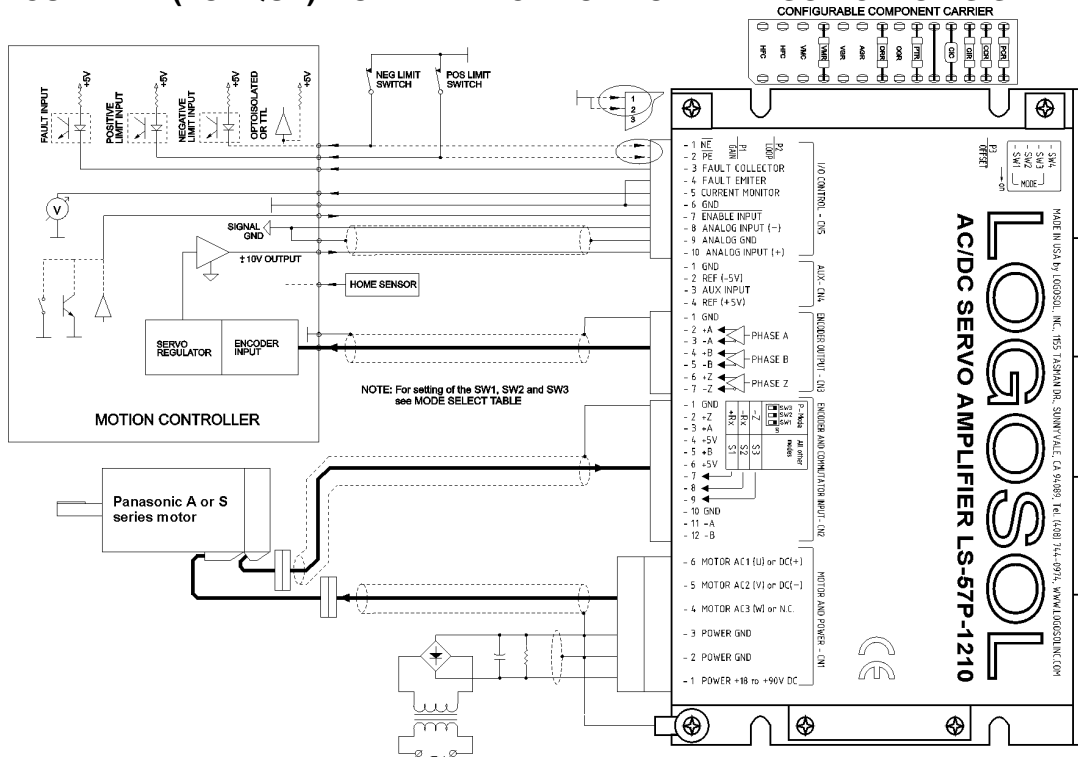

TYPICAL VELOCITY MODE APPLICATION FOR PANASONIC A OR S SERIES MOTORS

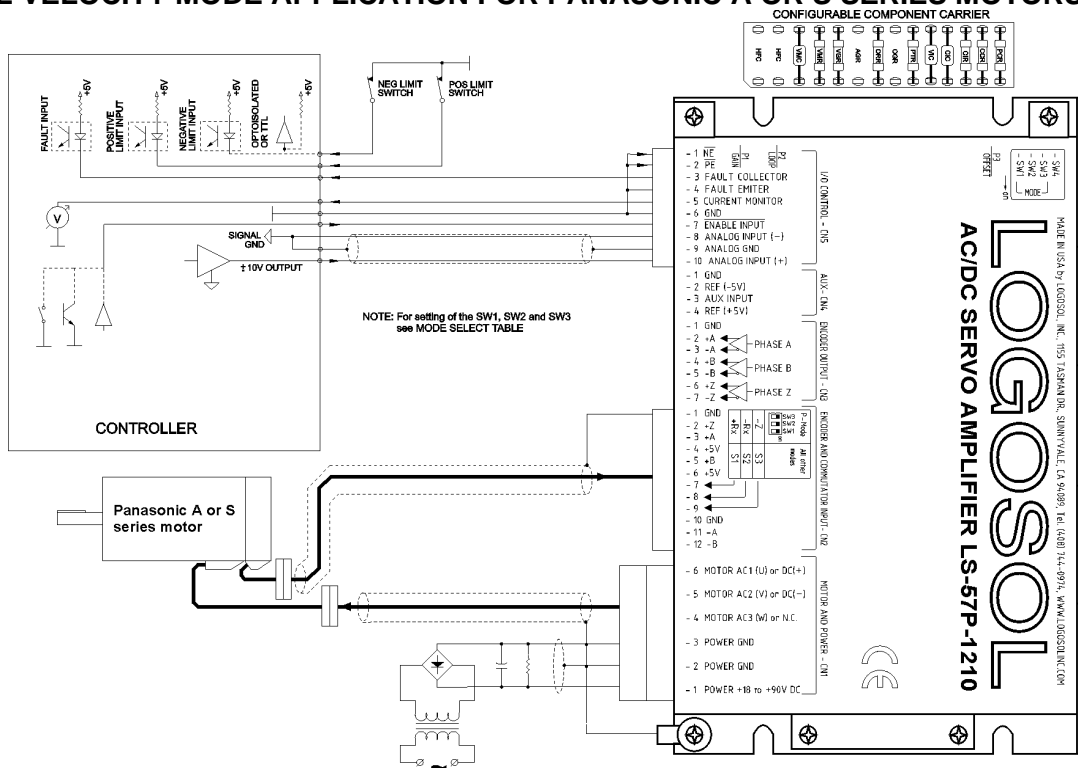

Logosol AC/DC Servo Amplifier LS-57P

Doc #713057001 / Rev. 1.5, 06/05/2002

TYPICAL ANALOG POSITION MODE APPLICATION FOR PANASONIC A OR S SERIES MOTORS

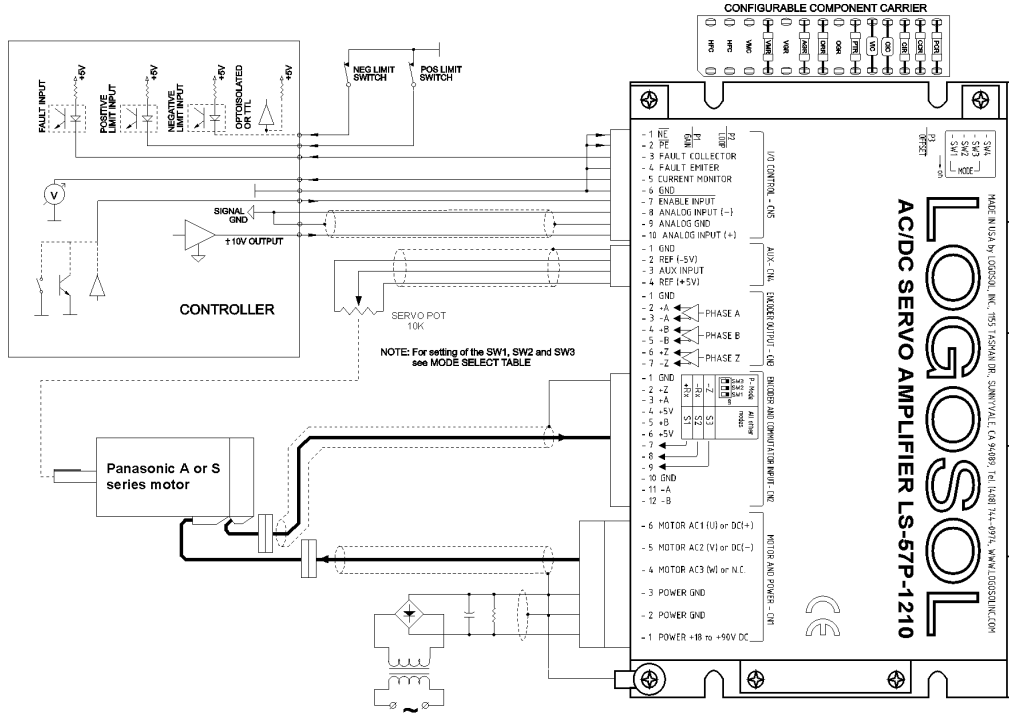

TYPICAL STAND ALONE MODE APPLICATION FOR PANASONIC A OR S SERIES MOTORS

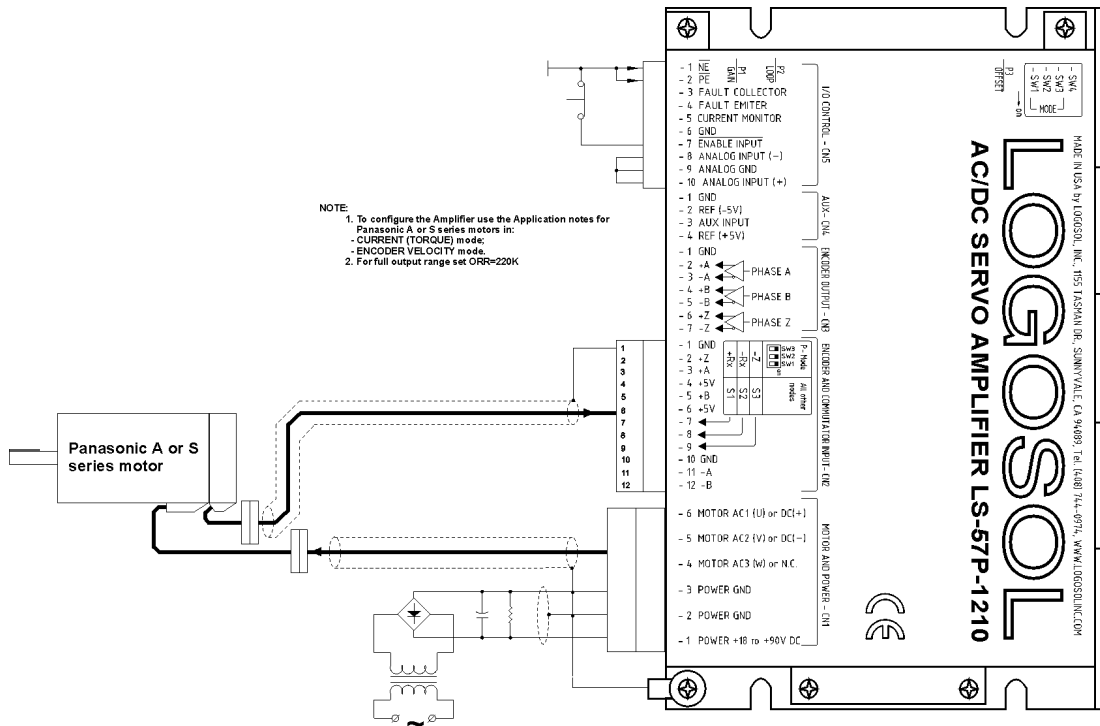

Logosol AC/DC Servo Amplifier LS-57P

Doc #713057001 / Rev. 1.5, 06/05/2002

EXTENSION CABLES FOR PANASONIC A AND S SERIES MOTORS

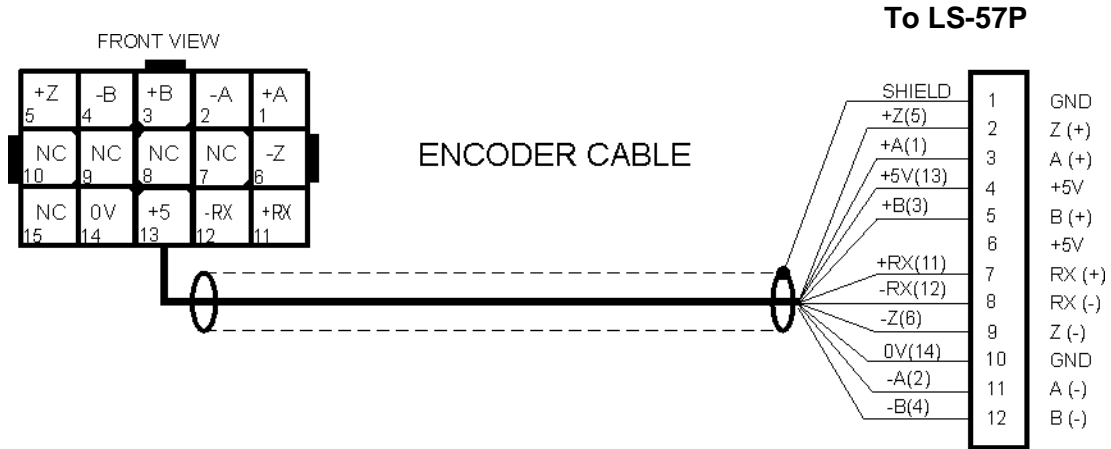

MOTOR CONNECTOR (AMP CAP 172163-1) 10 pins 170365-1		LS-57P CONNECTOR (MOLEX 22-01-3127) 11 pins 08-50-0114	
PIN#	SIGNAL NAME	PIN#	SIGNAL NAME
1	+ A channel output	3	A (+)
2	- A channel output	11	A (-)
3	+ B channel output	5	B (+)
4	- B channel output	12	B (-)
5	+ Z channel output	2	Z (+)
6	- Z channel output	9	Z (-)
11	+RX	7	RX (+)
12	-RX	8	RX (-)
13	+5V	4	+5V
14	0V	10	GND
NA	NA	1	GND (SHIELD)

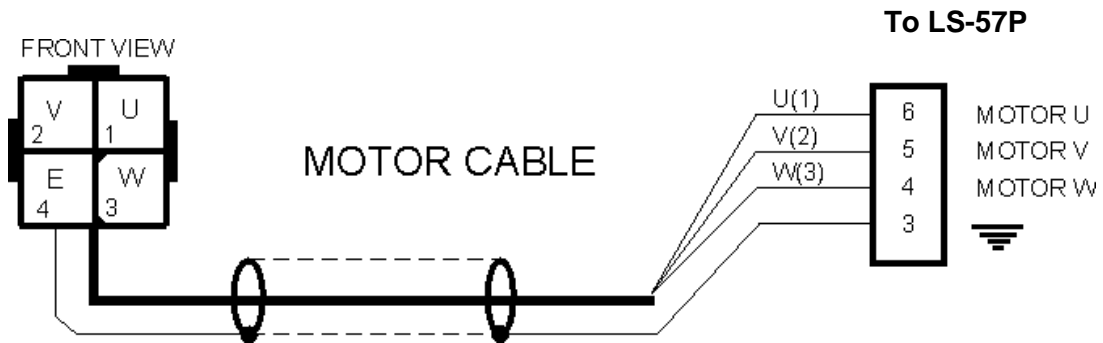

MOTOR CONNECTOR (AMP CAP 172159-1) 4 pins 170366-1		LS-57P CONNECTOR (PHOENIX CONTACT MSTB2.5/4-ST-5.08)	
PIN#	SIGNAL NAME	PIN#	SIGNAL NAME
1	U phase	6	MOTOR U
2	V phase	5	MOTOR V
3	W phase	4	MOTOR W
4	E=motor frame	3	⏏ (SHIELD)

Logosol AC/DC Servo Amplifier LS-57P

Doc #713057001 / Rev. 1.5, 06/05/2002

PANASONIC A AND S SERIES MOTORS WIRING DIAGRAM

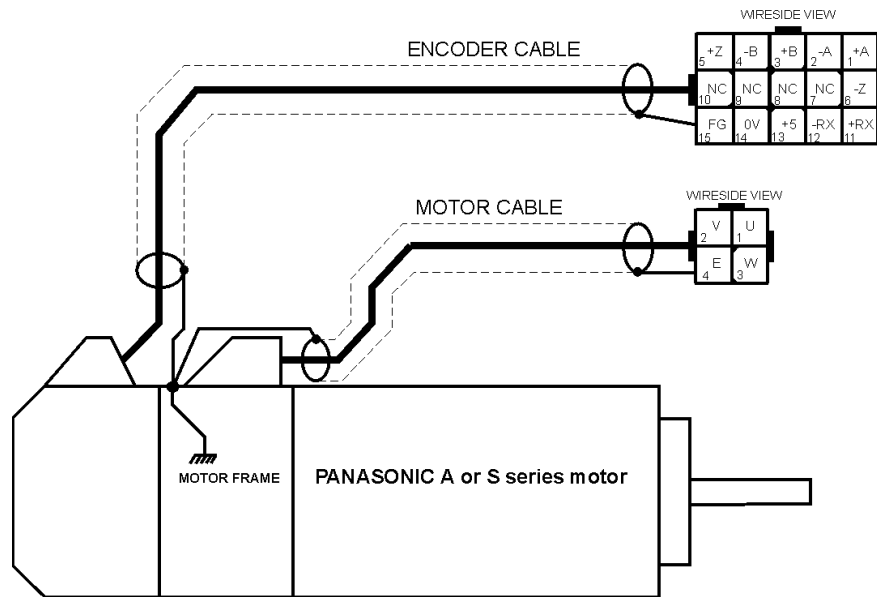

ENCODER CONNECTOR		
PIN#	SIGNAL NAME	COLOR
1	+ A channel output	Red
2	- A channel output	Pink
3	+ B channel output	Green
4	- B channel output	Blue
5	+ Z channel output	Yellow
6	- Z channel output	Orange
7	NC	NA
8	NC	NA
9	NC	NA
10	NC	NA
11	+RX	Light blue
12	-RX	Purple
13	+5V	White
14	0V	Black
15	FG = motor frame	Black

MOTOR CONNECTOR		
PIN#	SIGNAL NAME	COLOR
1	U phase	Red
2	V phase	White
3	W phase	Black
4	E = motor frame	Green/yellow